

HYDRAULIC CRANES / HYDRAULIC PRESSES / JACKS / TRANSMISSION JACKS

Gru idrauliche / Presse idrauliche / Cric / Cric da fossa

Hydraulische Werkstattkräne / Hydraulische Werkstattpressen / Wagenheber / Getriebeheber

Grues hydrauliques / Presses hydrauliques / Crics / Vérins de fosse

Grúas hidráulicas / Prensas hidráulicas / Gatos / Gatos para fosa







W E R T H E R

Via F. Brunelleschi, 12 - 42124 Cadè (RE) Italy
Tel. +39 0522 9431 +39 346 98 37 325 +39 346 98 37 443
Fax +39 0522 941997 e-mail: sales@wertherint.com

www.wertherint.com







-  Gru idrauliche
-  Hydraulic cranes
-  Hydraulische Kräne
-  Grues hydrauliques
-  Grúas hidráulicas



SE= Semplice effetto
SE= Single action pump
SE= Einfachwirkende Pumpe
SE= Pompe simple effet
SE= Acción simple

W141SE

-  Valvola limitatrice di carico • Comando tipo uomo presente • Stelo cromato
-  **Overload safety-valve • Dead man controls • Chromium plated rod**
-  Überlastsicherung • Totmann-Senkventil • Verchromte Kolbenstange
-  Sécurité hydraulique en cas de surcharge • Commande de type "homme mort" • Tige chromée
-  Válvula limitadora de carga • Mando de tipo hombre presente • Vástago cromado

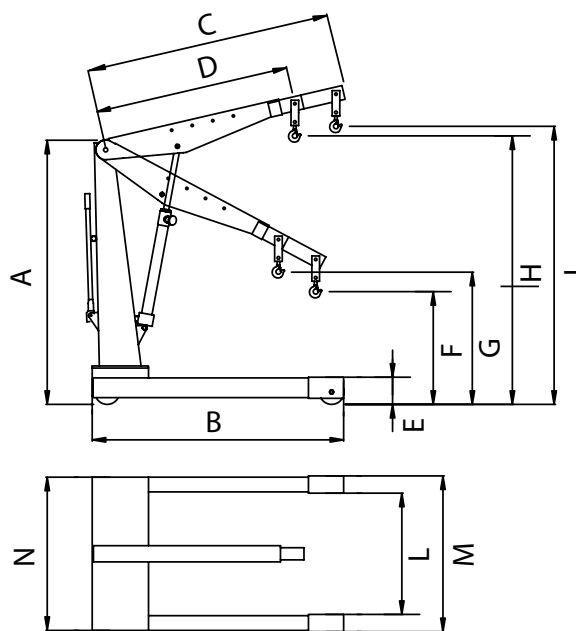

Dati tecnici

Technical data

Technische Eigenschaften

Caractéristiques techniques

Datos técnicos

	W140 W140SE	W141 W141/SE	W142	W143
A	1620	1750	1840	1990
B	1350	1560	1790	1970
C	1300	1550	1850	1970
D	1000	1250	1400	1520
E	160	165	195	220
F	520	620	430	520
G	730	800	720	800
H	2200	2520	2820	2930
I	2400	2750	3220	3270
L	780	920	880	980
M	900	1050	1050	1120
N	640	750	1000	1100
kg	65	100	180	220







Kg





	1	2	3	4
1	500	1000	1500	2000
2	400	800	1200	1500
3	350	650	800	1000
4	250	450	500	600

W106 | 2000 kg



-  Gru idrauliche serie pesante, doppio effetto
-  **Heavy duty hydraulic cranes, double acting**
-  Hydraulische Kräne, doppeltwirkend, schwere Serie
-  Grues hydrauliques série renforcée, double effet
-  Grúas hidráulicas serie pesada, doble acción



-  Pompa a doppio effetto • Valvola limitatrice di carico • Comando tipo uomo presente • Stelo cromato
-  **Double acting pump • Overload safety-valve • Dead man controls • Chromium plated rod**
-  Doppeltwirkende Pumpe • Überlastsicherung • Totmann-Senkventil • Verchromte Kolbenstange
-  Pompe double effet • Sécurité hydraulique en cas de surcharge • Commande de type "homme mort" • Tige chromée
-  Bomba de doble acción • Válvula limitadora de carga • Mando de tipo hombre presente • Vástago cromado

W106 | 2000 kg

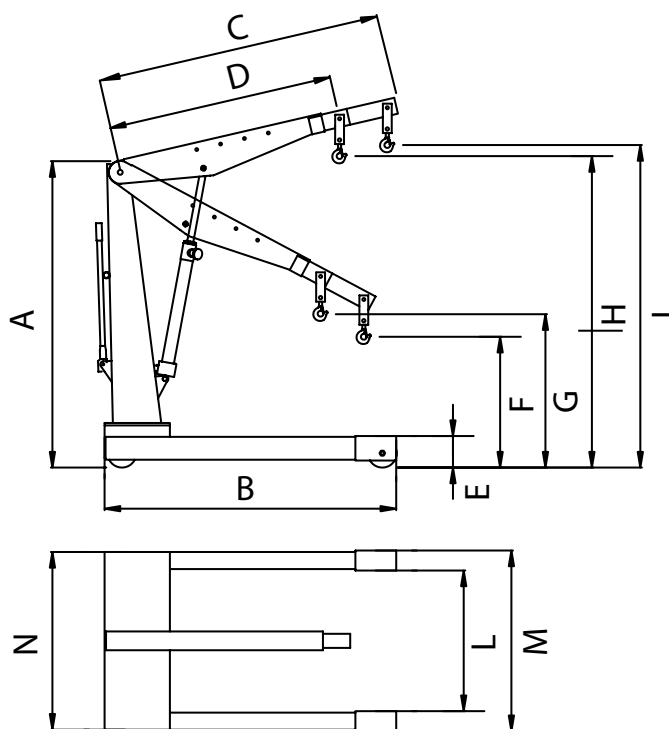

Dati tecnici

Technical data

Technische Eigenschaften

Caractéristiques techniques

Datos técnicos

	W106
A	2000
B	1970
C	1950
D	1500
E	220
F	530
G	810
H	2930
I	3280
L	1150
M	1350
N	1340
kg	300

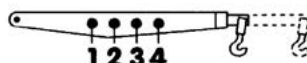

Kg

1	2000
2	1500
3	1000
4	600

W107 - W107SE - W107LP - W107SE/LPG - W108 W108SE - W108LP - W108SE/LPG

500-1000 kg



Gru idrauliche pieghevoli

Hydraulic folding cranes

Hydraulischer, klappbarer Kran

Grues hydrauliques pliable

Grúas hidráulica plegable



LP

- LP = Ribassato
- **LP = Low profile**
- LP = Tiefgesetzt
- LP = Surbaisse
- LP = Perfil bajo

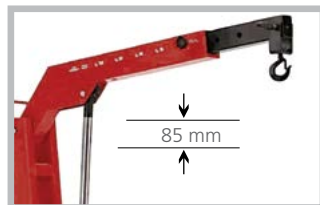

SE

- SE = Semplice effetto
- **SE = Single action pump**
- SE = Einfachwirkende Pumpe
- SE = Pompe simple effet
- SE = Acción simple

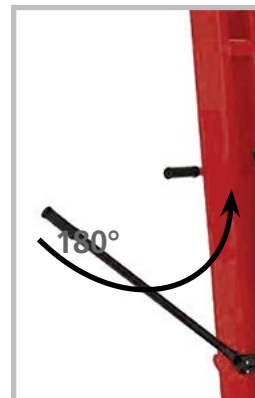

G

- G = Pompa pivotante
- **G = Pivoting pump**
- G = Drehbar gelagerte Pumpe
- G = Pompe pivotante
- G = Bomba pivotante

Valvola limitatrice di carico • Comando tipo uomo presente • Comando di discesa proporzionale • Stelo cromato

Overload safety-valve • Feet guards • Proportional lowering control • Chromium plated rod

Überlastventil • Totmann-Senksteuerung • Proportionale Senksteuerung • Verchromte Kolbenstange

Sécurité hydraulique en cas de surcharge • Commande de type "homme mort" • Commande de descente proportionnelle • Tige chromée

Válvula limitadora de carga • Mando de tipo hombre presente • Mando de descenso proporcional • Vástago cromado

W107 - W107SE - W107LP - W107SE/LPG - W108 W108SE - W108LP - W108SE/LPG

500-1000 kg



	SE		LP		G	
Modello	Con pompa a semplice effetto	Con pompa a doppio effetto	Basso profilo (gambe)	Pompa pivotante	Portata	
Model	With single action pump	With double action pump	Low profile (legs)	Pivoting pump	Capacity	
Modell	Mit einfachwirkender Pumpe	Mit doppeltwirkender Pumpe	Niedrige Bauhöhe (Beine)	Drehbar gelagerte Pumpe	Tragkraft	
Modèle	Avec pompe simple effect	Avec pompe double effect	Profil surbaissé (pieds)	Pompe pivotante	Capacité	
Modelo	Con bomba de acción simple	Con bomba de doble acción	Perfil bajo (patas)	Bomba pivotante	Capacidad de carga	
W107		X				500 Kg
W107SE	X					500 Kg
W107LP		X	X			500 Kg
W107SE/LP G	X		X	X		500 Kg
W108		X				1000 Kg
W108SE	X					1000 Kg
W108LP		X	X			1000 Kg
W108SE/LP G	X		X	X		1000 Kg



Dati tecnici

Technical data

Technische Eigenschaften

Caractéristiques techniques

Datos técnicos

	W107 W107SE	W108 W108SE	W107LP W107SE/LPG	W108LP W108SE/LPG
A	1600	1650	1580	1595
B	1540	1560	1490	1505
C	1200	1380	1200	1380
D	900	1080	900	1080
E	140	165	85	85
F	330	470	385	480
H	1940	2220	1875	2185
I	2070	2400	2005	2390
L	720	835	700	760
M	885	1000	905	1010
N	440	550	450	550
kg	80	110	85	118

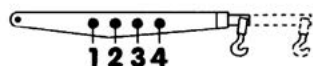
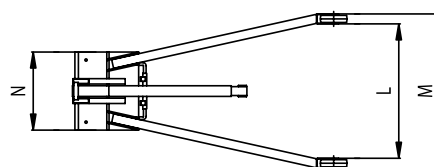
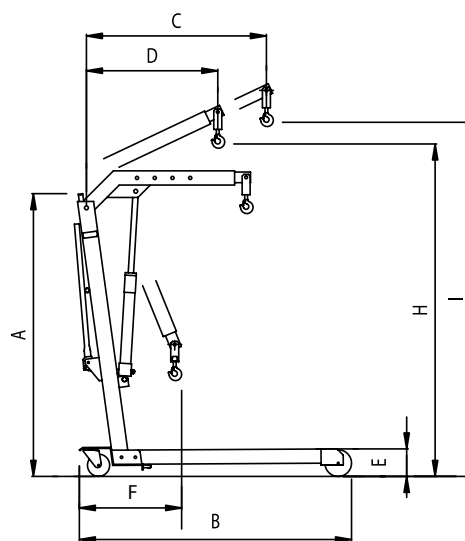





Kg				
1	500	1000	500	1000
2	400	800	400	800
3	350	650	350	650
4	250	450	250	450

PR10BPM - PR15BPM





10-15 t



-  Pressa idraulica da banco con pistone mobile
-  Hydraulic workbench press with moveable piston
-  Hydraulische Standpresse mit verschiebbarem Kolben
-  Presse hydraulique d'établi avec piston mobile
-  Prensa hidráulica de banco con pistón móvil



PR15BPM

-  Pompa a mano a due velocità • Sicurezza idraulica in caso di sovraccarico • Ritorno automatico del pistone • Stelo cromato • Manometro • Serie di prismi a V
-  Double-speed hand pump • Overload safety-valve • Automatic return of the ram • Chromium plated rod • Pressure gauge • V-blocks
-  Zweistufige Handpumpe • Überlastsicherung • Automat. Kolbenrücklauf • Verchromte Kolbenstange • Manometer • V-Prismen
-  Pompe manuelle double vitesse • Sécurité hydraulique en cas de surcharge • Retour automatique du piston • Tige chromée • Manomètre • Jeu de prismes à V
-  Bomba de mano con dos velocidades • Seguridad hidráulica en caso de sobrecarga • Retorno automático del pistón • Vástago cromado • Manómetro • Serie de prismas en V

PR10BPM - PR15BPM

10-15 t



Dati tecnici

Technical data

Technische Eigenschaften

Caractéristiques techniques

Datos técnicos

	PR10BPM	PR15BPM
A	1250	1350
B	620	690
C	500	500
D	500	550
E	150	150
F	500	550
G	160	160
H	820	900
L	300	340
kg	90	105

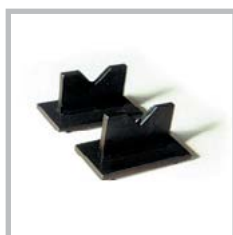
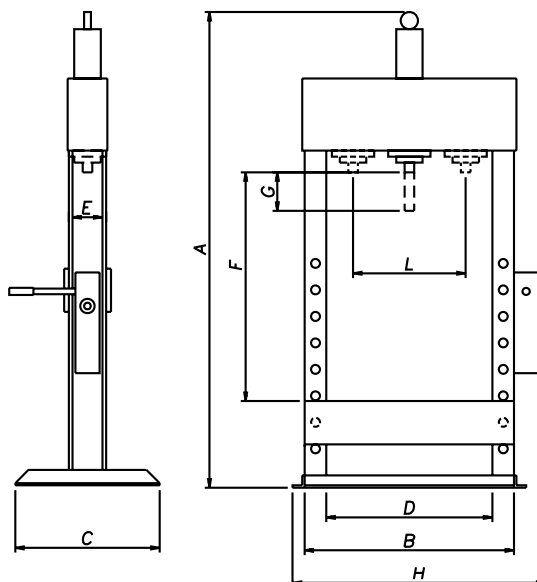

Prismi
V-blocks
Prismensatz
Prismes à 'V'
Prismas



Opzioni

Optionals

Sonderzubehör

Options

Opcionales



Piastra cacciaspine
Press plate
Abdrückplatte
Plaque d'extraction
Placa extractora de pasadores



Ø 29 24 18 14 10 5

Kit punzoni
Plugs
Stempelset
Kit de poinçons
Juego de punzones

PR10PM - PR15PM - PR20PM - PR25PM PR30PM - PR50PM

10-50 t



PR10PM (10 t) - PR15PM (15 t) - PR20PM (20 t) - PR25PM (25 t)

- Pressa idraulica a colonna con pistone mobile
- Hydraulic press with moveable piston
- Hydraulische Säulen- Werkstattpresse mit beweglichem Kolben
- Presse hydraulique à colonne avec piston mobile
- Prensa hidráulica de columna con pistón móvil

PR30PM (30 t) - PR50PM (50 t)

- Pressa idraulica a colonna con pistone mobile e argano
- Hydraulic press with moveable piston and lifting winch
- Hydraulische Säulen-Werkstattpresse mit beweglichem Kolben und Arbeitstisch-Hubwinde
- Presse hydraulique à colonne avec piston mobile et treuil
- Prensa hidráulica de columna con pistón móvil y cabrestante

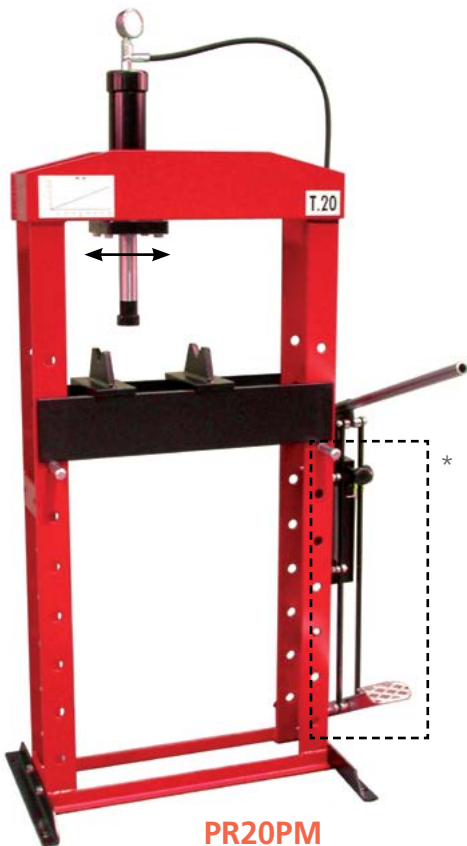

PR20PM

* Optional



PR50PM

- Pompa a mano a due velocità • Sicurezza idraulica in caso di sovraccarico • Ritorno automatico del pistone • Stelo cromato • Manometro • Serie di prismi a V
- Double-speed hand pump • Overload safety-valve • Automatic return of the ram • Chromium plated rod • Pressure gauge • V-blocks
- Zweistufige Handpumpe • Überlastsicherung • Automat. Kolbenrücklauf • Verchromte Kolbenstange • Manometer • V-Prismen
- Pompe manuelle double vitesse • Sécurité hydraulique en cas de surcharge • Retour automatique du piston • Tige chromée • Manomètre • Jeu de prismes à V
- Bomba de mano con dos velocidades • Seguridad hidráulica en caso de sobrecarga • Retorno automático del pistón • Vástago cromado • Manómetro • Serie de prismas en V

PR10PM - PR15PM - PR20PM - PR25PM PR30PM - PR50PM

10-50 t



Dati tecnici

Technical data

**Technische
Eigenschaften**

**Caractéristiques
techniques**

Datos técnicos

	PR10PM	PR15PM	PR20PM	PR25PM	PR30PM	PR50PM
A	1880	1880	1900	1900	1980	2200
B	620	690	770	770	890	980
C	600	600	600	600	600	700
D	500	550	610	610	710	780
E	150	150	150	150	150	165
F	1000	1000	1000	1000	1000	1000
G	160	160	160	160	160	160
H	820	900	950	950	1150	1250
L	300	340	380	380	450	500
kg	100	120	140	160	230	350

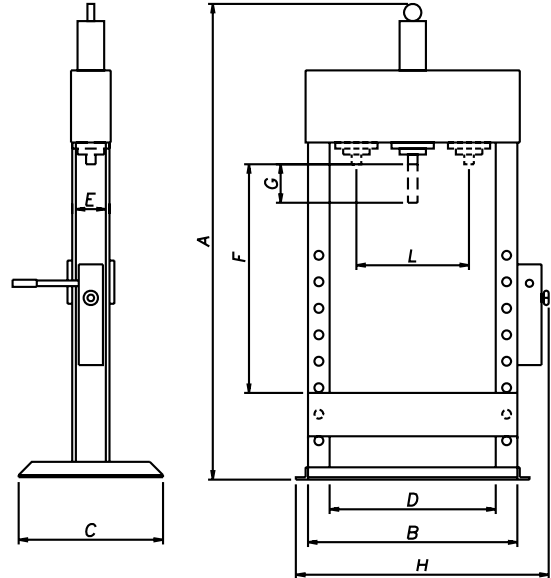

Prismi
V-blocks
Prismensatz
Prismes à 'V'
Prismas



Opzioni

Optionals

Sonderzubehör

Options

Opcionales



Piastra cacciaspine
Press plate
Abdrückplatte
Plaque d'extraction
Placa extractora de pasadores



Ø 29 24 18 14 10 5
Kit punzoni
Plugs
Stempelset
Kit de poinçons
Juego de punzones



Comando a pedale
Pedal drive
Fusspedal
Commande à pédale
Mando a pedal

PR15PM/S - PR20PM/S PR30PM/S - PR50PM/S

15-50 t



PR15 PM/S (15t) - PR20 PM/S (20t)

- Pressa idraulica a colonna con pistone mobile
- Hydraulic press with moveable piston
- Hydraulische Säulen-Werkstattpresse mit beweglichem Kolben
- Presse hydraulique à colonne avec piston mobile
- Prensa hidráulica de columna con pistón móvil



PR20PM/S

PR30 PM/S (30t) - PR50 PM/S (50t)

- Pressa idraulica a colonna con pistone mobile e argano
- Hydraulic press with moveable piston and lifting winch
- Hydraulische Säulen-Werkstattpresse mit beweglichem Kolben und Arbeitstisch-Hubwinde
- Presse hydraulique à colonne avec piston mobile et treuil
- Prensa hidráulica de columna con pistón móvil y cabrestante

- Pompa a mano a due velocità • Sicurezza idraulica in caso di sovraccarico • Ritorno automatico del pistone • Stelo cromato • Manometro • Serie di prismi a V
- Double-speed hand pump • Overload safety-valve • Automatic return of the ram • Chromium plated rod • Pressure gauge • V-blocks
- Zweistufige Handpumpe • Überlastsicherung • Automat. Kolbenrücklauf • Verchromte Kolbenstange • Manometer • V-Prismen
- Pompe manuelle double vitesse • Sécurité hydraulique en cas de surcharge • Retour automatique du piston • Tige chromée • Manomètre • Jeu de prismes à V
- Bomba de mano con dos velocidades • Seguridad hidráulica en caso de sobrecarga • Retorno automático del pistón • Vástago cromado • Manómetro • Serie de prismas en V

PR15PM/S - PR20PM/S PR30PM/S - PR50PM/S

15-50 t



Dati tecnici

Technical data

Technische Eigenschaften

Caractéristiques techniques

Datos técnicos

PM/S

	PR15PM/S	PR20PM/S	PR30PM/S	PR50PM/S
A	1700	1750	1920	2000
B	810	870	990	990
C	650	650	650	650
D	630	690	790	790
E	180	180	200	210
F	1000	950	1030	1000
G	150	160	160	150
H	950	1010	1240	1400
L	400	450	550	500
kg	180	210	280	360

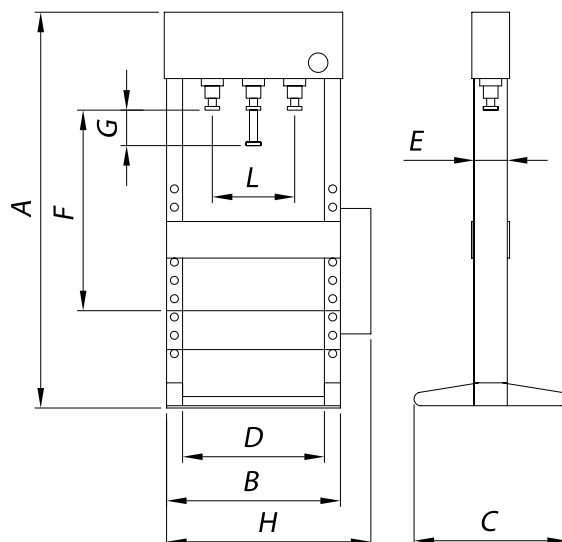

PR30PM/S
PR50PM/S

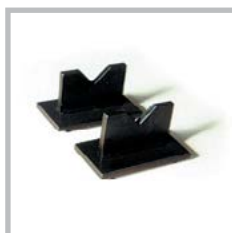

Prismi
V-blocks
Prismensatz
Prismes à 'V'
Prismas



Opzioni

Optionals

Sonderzubehör

Options

Opcionales



Piastra cacciaspine
Press plate
Abdrückplatte
Plaque d'extraction
Placa extractora de pasadores



Ø 29 24 18 14 10 5

Kit punzoni
Plugs
Stempelset
Kit de poinçons
Juego de punzones

PRM50 - PRM100 - PRM150 PRM50PM - PRM100PM - PRM150PM

50-150 t



PRM50 (50 t) - PRM100 (100 t) - PRM150 (150 t)

- Pressa idraulica motorizzata
- Electro-hydraulic press**
- Hydraulische Standpresse mit Motorantrieb
- Presse hydraulique motorisée
- Prensa hidráulica motorizada



PRM150

PRM50PM (50 t) - PRM100PM (100 t) - PRM150PM (150 t)

- Pressa idraulica motorizzata con pistone mobile
- Electro-hydraulic press with moveable piston**
- Hydraulische Standpresse mit Motorantrieb und beweglichem Kolben
- Presse hydraulique motorisée avec piston mobile
- Prensa hidráulica motorizada con pistón móvil

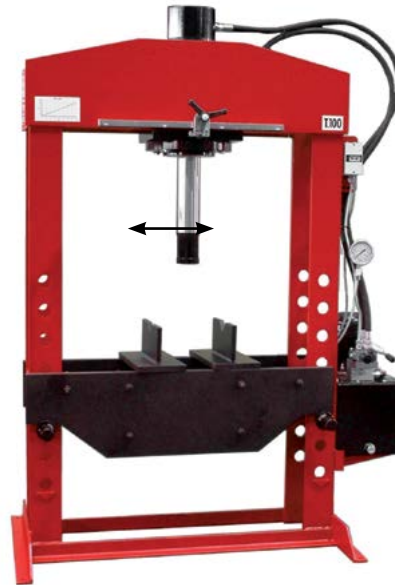

PRM100 PM



Prismi
V-blocks
Prismensatz
Prismes à 'V'
Prismas

- Sicurezza idraulica in caso di sovraccarico • Comando con distributore • Manometro • Centralina doppia velocità
- Overload safety-valve • Manual up/down control valve • Pressure gauge • Double speed control unit**
- Überlastsicherung • Auf-/Ab-Steuerventil • Manometer • Doppelgeschwindigkeit-Steuergehäuse
- Sécurité hydraulique en cas de surcharge • Commande par distributeur • Manomètre • Centrale double vitesse
- Seguridad hidráulica en caso de sobrecarga • Mando con distribuidor • Manómetro • Centralita doble velocidad

Sollevamento del piano di lavoro Lifting of working platform Heben/Senken des Arbeitstisches Levage/déscente de la table de travail Elevación del plano de trabajo	PRM50	PRM50PM	PRM100	PRM100PM	PRM150	PRM150PM
Argano/cable winch/Seilwinde/treuil/cabrestante	x	x				
Catena/chain/Kette/chaîne/cadena			x	x	x	x
Prismi / V-blocks / Prismensatz / Prismes à 'V' / Prismas	x	x	x	x		

PRM50 - PRM100 - PRM150 PRM50PM - PRM100PM - PRM150PM

50-150 t



Dati tecnici

Technical data

Technische Eigenschaften

Caractéristiques techniques

Datos técnicos

	PRM50	PRM50PM	PRM100	PRM100PM	PRM150	PRM150PM
A	2290	2290	2280	2280	2450	2450
B	985	985	1290	1290	1440	1440
C	650	650	850	850	1000	1000
D	790	790	1030	1030	1020	1020
E	210	210	305	305	360	360
F-	65	65	240	240	230	230
F+	1050	1050	1000	1000	1020	1020
G	250	250	320	320	400	400
H	1350	1350	1600	1600	1950	1950
I	350	350	350	350	550	550
L	-	520	-	650	-	600

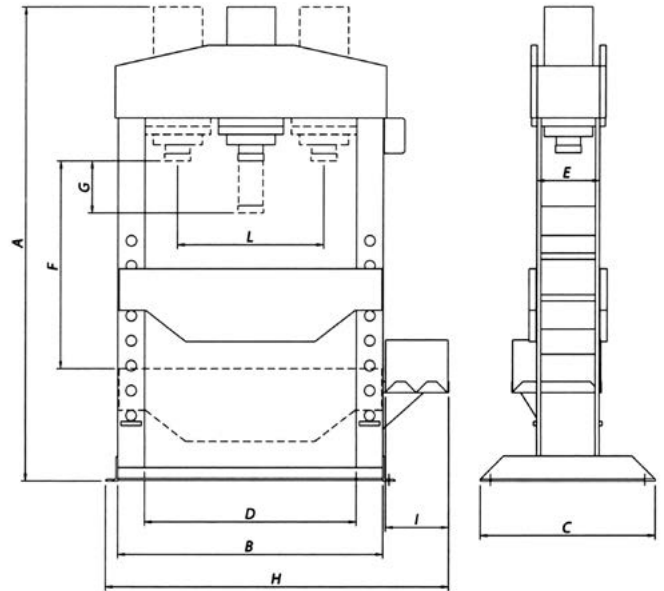

						PRM50 PRM50PM	PRM100 PRM100PM	PRM150 PRM150PM
Potenza	Power	Leistung	Puissance	Potencia	kw	1,5	1,5	3,0
Portata centralina	Hydraulic unit capacity	Öldurchflussmenge	Capacité du groupe hydraulique	Capacidad centralita	lt/1'	8,8 / 1,4	15,4 / 2,1	30 / 4,5
Corsa stelo	Rod stroke	Hubkapazität des Kolbens	Course du piston	Carrera vástago	mm	250	320	400
Velocità stelo	Rod speed	Geschwindigkeit des Kolbens	Vitesse du piston	Velocidad vástago	mm/1"	20 / 1,7	16 / 1,5	23 / 1,7
Peso	Weight	Gewicht	Poids	Peso	kg	430	980	1680



Opzioni

Optionals

Sonderzubehör

Options

Opcionales



Piastra cacciapine
Press plate
Abdrückplatte
Plaque d'extraction
Placa extractora de pasadores



Ø 29 24 18 14 10 5
Kit punzoni
Plugs
Stempelset
Kit de poinçons
Juego de punzones

 Carrello sollevatore per ruote

 Wheel lifter

 Radheber

 Élévateur de roue

 Carrito elevador de ruedas



 Soluzione ergonomica per smontare, spostare e montare in modo facile e sicuro ruote in alluminio fino a 24" con pneumatici a profilo basso (Diametro esterno massimo 820 mm) • Sollevamento facile a pedale • Rulli con cuscinetti a sfera per ruotare e posizionare facilmente • Facile accesso ai bulloni delle ruote. La ruota è posizionata lontano dal pistone principale.

 It is an ergonomic solution for easy and safe demounting, handling and mounting of low profile aluminium wheels up to 24" (Outside diameter max. 820 mm.) • Effortless foot operated lifting • Rollers with ball bearings for easy rotation and positioning • Easy access to wheel bolts. The wheel is positioned away from the main piston.

 Ist eine ergonomische Lösung für die einfache und sichere Demontage, Montage und Hantierung von Alurädern bis 24" mit Niederprofilreifen. (Externer Durchmesser max. 820 mm.) • Mühelose Bedienung durch Fußschalter • Kugelgelagerte Rollen vereinfachen • Drehbewegungen und das Positionieren • Radbolzen leicht zugänglich. Das Rad zeigt vom Hauptkolben weg.

 C'est la solution ergonomique pour le démontage, la manipulation et le montage faciles et sûres de roues jusqu'à une taille de 24 pouces équipées de pneus de profil peu profonds (diamètre externe maxi: 820 mm.) • Levage sans efforts à commande à pied • Facilité de rotation et de positionnement permise par des galets montés sur roulements à billes • Accès facile aux écrous de la roue • La roue est positionnée à l'écart du piston principal.

 Solución ergonómica para desmontar, desplazar y montar fácilmente y de manera segura ruedas de aluminio de hasta 24" con neumáticos de perfil bajo. (Diámetro exterior máximo 820 mm) • Elevación fácil con mando a pedal • Rodillos con cojinetes de bolas para poder girar y colocar fácilmente • Acceso facilitado a los pernos de las ruedas. La rueda está situada lejos del pistón principal.

WD60

60 Kg



Dati tecnici

Technical data

Technische Eigenschaften

Caractéristiques techniques

Datos técnicos

Capacità: ruote fino a 60 kg.
Capacity: Wheels up to 60 kg.
Hubkraft: Räder bis 60 kg.
Capacité: roues jusqu'à 60 kg.
Capacidad: ruedas hasta 60 kg

Altezza massima presa 1100 mm
Max. lifting height 1100 mm
Max. Hubhöhe 1100 mm
Hauteur max. de levage 1100 mm
Altura máxima horquilla, 1.100 mm

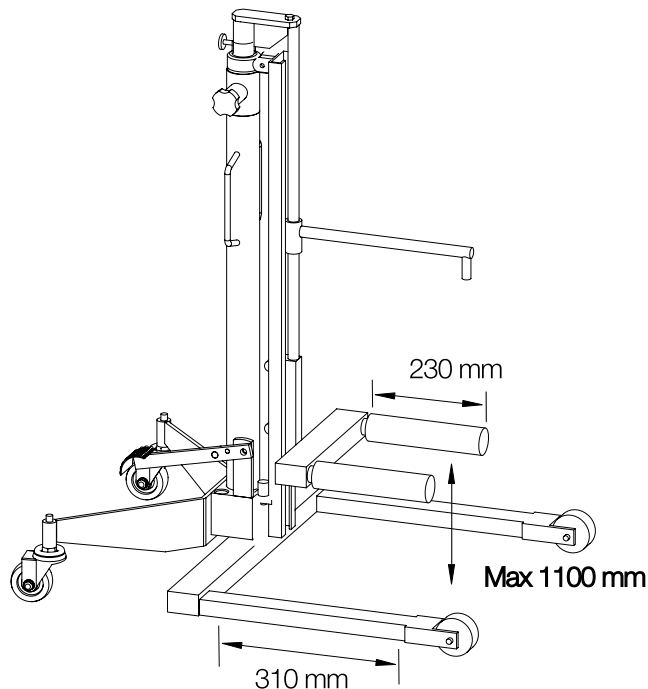

"Roll on - Roll off"

Non è necessario sollevare. La ruota rotola facilmente sulla base bassa.

No lifting required. Wheel rolls easily over low legs.





Macht Anheben überflüssig. Das Rad lässt sich problemlos über die niedrigen Füße rollen.

Pas d'élévation requise. Les roues roulent sans problèmes sur des pattes basses.

No es necesario elevar. La rueda rodará fácilmente sobre la base baja.







J2P

-  Cric pneumatico portatile a 2 stadi
-  **Pneumatic 2-stage jack**
-  Pneumatischer Wagenheber mit 2 Stufen
-  Cric pneumatique à 2 étages
-  Gato neumático portátil de 2 etapas







J3P





-  Cric pneumatico portatile a 3 stadi
-  **Pneumatic 3-stage jack**
-  Pneumatischer Wagenheber mit 3 Stufen
-  Cric pneumatique à 3 étages
-  Gato neumático portátil de 3 etapas



J2C

-  Cric pneumatico portatile a 2 stadi con carrello
-  **Pneumatic 2-stage jack with trolley**
-  Pneumatischer Wagenheber mit 2 Stufen, mit Wagen
-  Cric pneumatique à 2 étages à chariot
-  Gato neumático portátil de 2 etapas con carrito

J3C

-  Cric pneumatico portatile a 3 stadi con carrello
-  **Pneumatic 3-stage jack with trolley**
-  Pneumatischer Wagenheber mit 3 Stufen, mit Wagen
-  Cric pneumatique à 3 étages à chariot
-  Gato neumático portátil de 3 etapas con carrito

 Guida telescopica interna • Valvola di sicurezza • Dispositivo di arresto a fine corsa

 **Telescopic stabiliser • Safety valve • Stroke limiting device**





 Innere teleskopische Führung • Sicherheitsventil • Automatische Arretierung bei Maximalhöhe

 Guidage télescopique interne • Soupape de surpression • Dispositif d'arrêt à la hauteur maximale

 Guía telescópica interna • Válvula de seguridad • Dispositivo de paro en final de carrera





J2 - J3 | 2 t

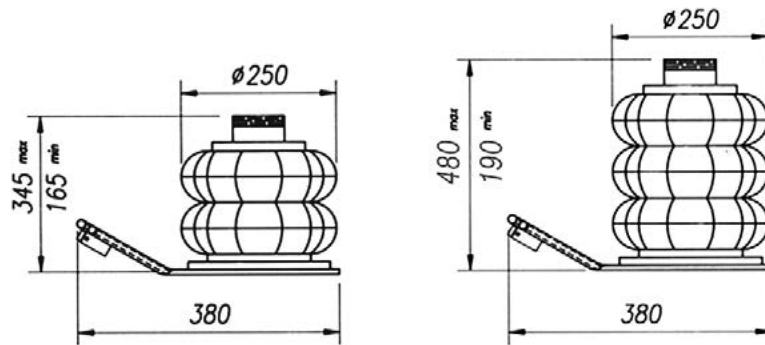





 Dati tecnici	 Technical data	 Technische Eigenschaften	 Caractéristiques techniques	 Datos técnicos		J2P	J3P
						J2C	J3C
Portata	Capacity	Tragfähigkeit	Capacité	Capacidad de carga	t	2	2
Pressione lavoro	Working pressure	Hubdruck	Pression de travail	Presión de trabajo	bar	7	7
Corsa	Stroke	Hubhöhe	Course	Carrera	mm	165	190
Peso	Weight	Gewicht	Poids	Peso	Kg	14	16



 Opzioni	 Optionals	 Sonderzubehör	 Options	 Opcionales
Prolunga 50mm Extension 50mm Verlängerung 50mm Rallonge 50mm Prolongación 50mm				
		Prolunga 100 mm Extension 100 mm Verlängerung 100 mm Rallonge 100 mm Prolongación 100mm		

-  Cric idraulici a carrello
-  Hydraulic trolley jacks
-  Hydraulische Rangierheber
-  Crics rouleurs hydrauliques
-  Gatos hidráulicos con carrito



-  Manico ergonomico per il comfort dell'utilizzatore. Ricoperto in gomma • Il sistema di discesa "solleva e gira" previene abbassamenti non intenzionali • Valvola di controllo abbassamento per una discesa sicura perfino con il massimo carico • Il pedale a piede addizionale permette un sollevamento veloce della sella • Ruote a diametro largo per movimentazione facile.
-  Ergonomically designed handle for operator comfort. Rubber coated • "Lift-and-turn" lowering system prevents unintentional lowering • Safety lowering control valve for safe lowering even under maximum load • Additional foot pedal pumping feature provides fast saddle raising to the load • Large diameter swivel wheels for easy handling.
-  Ergonomisch geformte gummiüberzogene Griffe für besseren Bedienkomfort • Heben und Drehen, Absenksystem schützt gegen unbeabsichtigtes Absacken von Lasten • Ein Sicherheitsventil zur Steuerung des Absenkvorganges gewährleistet das Ablassen von Lasten mit definierter Geschwindigkeit und schützt gegen unbeabsichtigtes Absacken von Lasten auch unter max. Traglast • Zusätzliches Fußpedal zum schnellen Hochfahren des Sattels (Schnellhub) • Grosse Schwenkrollen für Stabilität und Wendigkeit unter Last.
-  Poignée de conception ergonomique pour un grand confort d'utilisation. Revêtement de caoutchouc • "Dispositif de descente "levage et blocage" empêchant toute descente intempestive • La pédale additionnelle de pompage assure un levage rapide du sabot d'appui vers la charge • Vanne-pilote de sécurité pour une descente sûre, même sous la charge maximale • Roues pivotantes de grand diamètre pour manutention facile.
-  Mango ergonómico para el confort del usuario. Revestido en goma • El sistema de descenso "eleva y gira" previene bajadas no intencionadas • Válvula de control de bajada para un descenso seguro también con la carga máxima • El pedal adicional permite una elevación rápida de la silla • Ruedas de diámetro grande para un desplazamiento facilitado.



Dati tecnici

Technical data

Technische Eigenschaften

Caractéristiques techniques

Datos técnicos

MOD.	Max (Ton)	A (mm)	B (mm)	C (mm)	D (mm)	E (mm)	F (mm)	Kg
WJC2T-C	2	80	500	730	160	380	925	37
WJF2T-77	2	77	480	950	126	380	925	41
WJC3T-C	3	115	500	1015	170	380	925	42

Ruote in nylon per la riduzione del rumore

Noise reducing nylon wheels

Serienmäßig mit geräuscharmen Kunststoffräder

Roues en nylon silencieuses

Ruedas en nylon para reducir el ruido

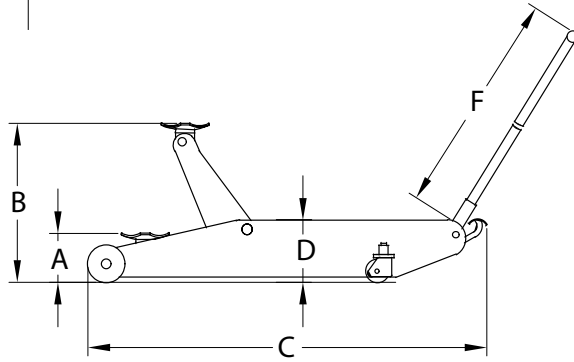
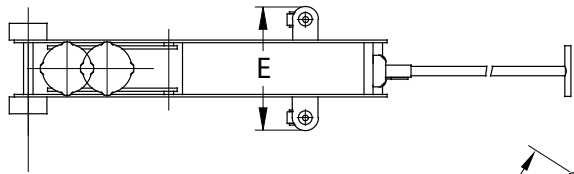

Altezza di entrata ultra bassa

Ultra low entry height

Ultraflache Aufnahmehöhe

Prise très basse de la charge

Altura de entrada ultra baja



Opzioni

Optionals

Sonderzubehör

Options

Opcionales



CD0601

WJC2T-C - WJF2T-F

Il sistema boogie è ideale per le officine con pavimento non pari ed all'esterno - Rulli e ruote in poliuretano

The boogie system is ideal for workshops with uneven floors and outdoors - Polyurethane rollers and wheels

Ideal für Karosserie Die Boogie - und Lackierwerkstätten - Rollen und Räder aus Polyurethan

Les roues boogie sont idéales pour les ateliers aux sols inégaux et à l'extérieur des bâtiments - Rouleaux et roues en polyuréthane

El sistema de ruedas boogie es ideal para los talleres con piso irregular y al aire libre - Rodillos y ruedas de poliuretano



CD0603

WJF2T-F (+40mm) - WJ3T-C (+40mm)

Sella per altezze extra o accesso a punti di sollevamento posti sotto alle minigonne, etc.

Saddle for extra height or accessing lifting points situated behind skirts, etc.

Sattelverlängerung für extra hohe Aufnahmen oder schwer zugängliche Hebeplätze, z.B. Hinter Blenden.

Selle pour hauteurs exceptionnelles ou pour l'accès à des points de levage situés hors limites, etc.

Silla para alturas extra o acceso a puntos de elevación situados debajo de las minifaldas, etc.



CD0602





Tappo in gomma

Rubber pad





Gummiauflage

Tampon en caoutchouc

Tapón de goma

-  Cricchi ad alta portata
-  High capacity jacks
-  Rangierheber mit hoher Tragkraft
-  Crics haute capacité
-  Gatos de alta capacidad de carga



-  Manico ergonomico per il comfort dell'utilizzatore. Ricoperto in gomma • Il sistema di discesa "solleva e gira" previene abbassamenti non intenzionali • Valvola di controllo abbassamento per una discesa sicura perfino con il massimo carico • Il pedale a piede addizionale permette un sollevamento veloce della sella • Ruote a diametro largo per movimentazione facile.
-  Ergonomically designed handle for operator comfort. Rubber coated • "Lift-and-turn" lowering system prevents unintentional lowering • Safety lowering control valve for safe lowering even under maximum load • Additional foot pedal pumping feature provides fast saddle raising to the load • Large diameter swivel wheels for easy handling.
-  Ergonomisch geformte gummiüberzogene Griffe für besseren Bedienkomfort • Heben und Drehen, Absenksystem schützt gegen unbeabsichtigtes Absacken von Lasten • Ein Sicherheitsventil zur Steuerung des Absenkvorganges gewährleistet das Ablassen von Lasten mit definierter Geschwindigkeit und schützt gegen unbeabsichtigtes Absacken von Lasten auch unter max. Traglast • Zusätzliches Fußpedal zum schnellen Hochfahren des Sattels (Schnellhub) • Grosse Schwenkrollen für Stabilität und Wendigkeit unter Last.
-  Poignée de conception ergonomique pour un grand confort d'utilisation. Revêtement de caoutchouc • "Dispositif de descente "levage et blocage" empêchant toute descente intempestive • La pédale additionnelle de pompage assure unlevage rapide du sabot d'appui vers la charge • Vanne-pilote de sécurité pour une descente sûre, même sous la charge maximale • Roues pivotantes de grand diamètre pour manutention facile.
-  Mango ergonómico para el confort del usuario. Revestido en goma • El sistema de descenso "eleva y gira" impide bajadas no intencionadas • Válvula de control de bajada para un descenso seguro también con la carga máxima • El pedal adicional permite una elevación rápida de la silla • Ruedas de diámetro grande para un desplazamiento facilitado.



Dati tecnici

Technical data

Technische Eigenschaften

Caractéristiques techniques

Datos técnicos

MOD.	Max (Ton)	A (mm)	B (mm)	C (mm)	D (mm)	E (mm)	F (mm)	Kg
WJK-6T/CK	6	145	560	1270	200	465	1045	70
WJK-10T/CK	10	155	570	1395	210	470	1045	90
WJK-12T/CK	12	170	690	1700	280	470	1045	136
WJK-20T/CK	20	200	600	1790	325	475	1480	164

Altezza min. 145 mm
Min. height 145 mm.
 Min. Hubhöhe 145 mm.
 Hauteur minimale 145 mm.
 Altura mín. 145 mm

Altezza minima del telaio 200 mm
Min. chassis height 200 mm
 Min. Chassishöhe 200 mm
 Hauteur minimale du châssis: 200 mm
 Altura mínima del chasis 200 mm

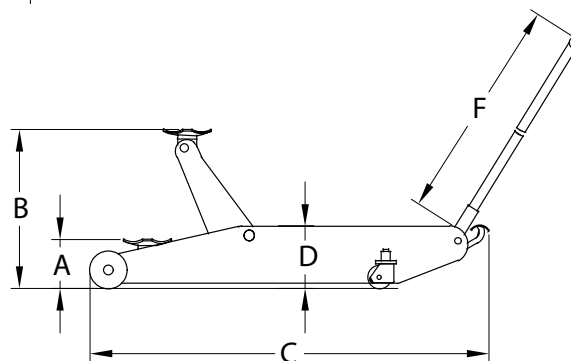
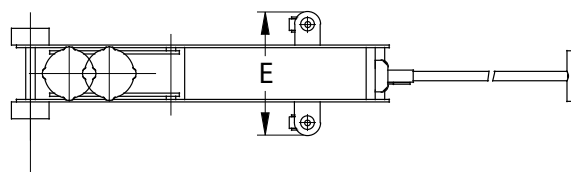

Altezza di entrata ultra bassa
Ultra low entry height
 Ultraflache Aufnahmehöhe
 Prise très basse de la charge
 Altura de entrada ultra baja



Opzioni

Optionals

Sonderzubehör

Options

Opcionales



CD0600

Le ruote ad aria in gomma fissate sul punto di equilibrio accrescono la manovrabilità dei grossi cricchi.

Air rubber tyres enhance manoeuvrability.

Zum Transport der Heber empfehlen wir Luftgummiräder.

Des pneumatiques améliorent la manoeuvrabilité.

Las ruedas neumáticas en goma, fijadas en el punto de equilibrio, aumentan la maniobrabilidad de los gatos grandes.



CD0603

WJK-10T / -12T / -20T (+ 40 mm)

Sella per altezze extra o accesso a punti di sollevamento posti sotto alle minigonne, etc.

Saddle for extra height or accessing lifting points situated behind skirts, etc.

Sattelverlängerung für extra hohe Aufnahmen oder schwer zugängliche Hebepunkte, z.B. Hinter Blenden.

Selle pour hauteurs exceptionnelles ou pour l'accès à des points de levage situés hors limites, etc.

Silla para alturas extra o acceso a puntos de elevación situados debajo de las minifaldas, etc.

 Cricchi a grande alzata

 High lift jacks

 Hochheber

 Crics à grande levée

 Gatos de gran elevación



 Manico ergonomico per il comfort dell'utilizzatore. Ricoperto in gomma • Il sistema di discesa "solleva e gira" previene abbassamenti non intenzionali • Il pedale a piede addizionale permette un sollevamento veloce della sella • Valvola di controllo abbassamento per una discesa sicura perfino con il massimo carico • Finitura a polvere. Struttura completamente saldata in acciaio di alta qualità • Ruote a diametro largo per movimentazione facile.

 Ergonomically designed handle for operator comfort. Rubber coated • "Lift-and-turn" lowering system prevents unintentional lowering • Additional foot pedal pumping feature provides fast saddle raising to the load • Safety lowering control nylon wheels.valve for safe lowering even under maximum load • Powder coated finish. Heavy duty fully welded structure in high quality steel • Large diameter swivel wheels for easy handling.

 Ergonomisch geformte gummiüberzogene Griffe für besseren Bedienkomfort • Heben und Drehen, Absenksystem schützt gegen unbeabsichtigtes Absacken von Lasten • Zusätzliches Fußpedal zum schnellen Hochfahren des Sattels (Schnellhub) • Ein Sicherheitsventil zur Steuerung des Absenkvorganges gewährleistet das Ablassen von Lasten mit definierter • Geschwindigkeit und schützt gegen unbeabsichtigtes Absacken von Lasten auch unter max. Traglast • Pulverbeschichtet. Robuste, voll verschweißte Stahlkonstruktion aus höchster Stahlqualität • Grosse Schwenkrollen für Stabilität und Wendigkeit unter Last.

 Poignée de conception ergonomique pour un grand confort d'utilisation. Revêtement de caoutchouc • "Dispositif de descente "levage et blocage" empêchant toute descente intempestive • La pédale additionnelle de pompage assure unlevage rapide du sabot d'appui vers la charge • Vanne-pilote de sécurité pour une descente sûre, même sous la charge maximale • Finition: peinture par poudrage. Structure d'acier haute qualité • Roues pivotantes de grand diamètre pour manutention facile.

 Mango ergonómico para el confort del usuario. Revestido en goma • El sistema de descenso "eleva y gira" precave bajadas no intencionadas • El pedal adicional permite una elevación rápida de la silla • Válvula de control de bajada para un descenso seguro también con la carga máxima • Acabado con pintura de polvos. Estructura completamente soldada en acero de alta calidad • Ruedas de diámetro grande para un desplazamiento facilitado.



Dati tecnici	Technical data	Technische Eigenschaften	Caractéristiques techniques	Datos técnicos				
MOD.	Max (Ton)	A (mm)	B (mm)	C (mm)	D (mm)	E (mm)	F (mm)	Kg
WJH-1,5T-HC	1,5	98	800	1050	169	380	925	52
WJH-2T-HC	2	98	735	1035	210	380	1045	53
WJH-3T-HC	3	130	860	1620	210	460	1045	88
WJH-5T-HC	5	180	960	1830	350	475	1045	151
WJH-8T-HC	8	180	960	1830	350	475	1045	160
WJH-10T-HC	10	210	770	1700	290	475	1045	139

Altezza max. 960 mm.
Max. height 960 mm.
 Maximale Hubhöhe 960 mm.
 Hauteur maxi.: 960 mm.
 Altura máx. 960 mm.

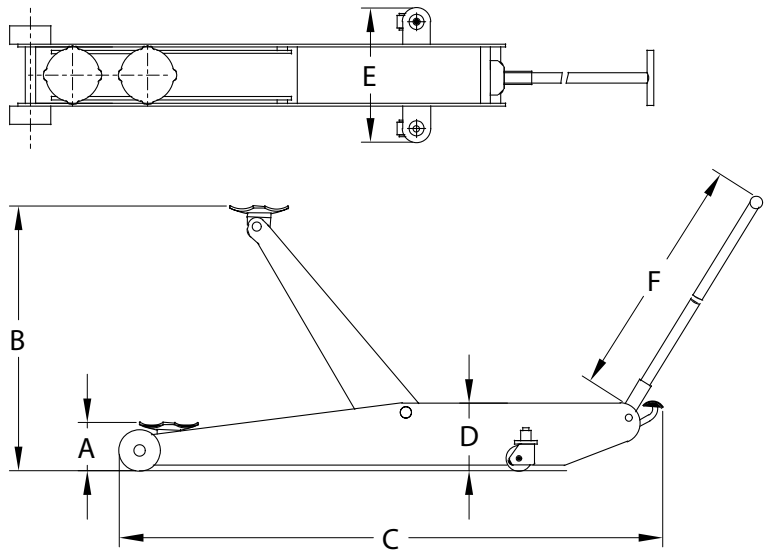

Opzioni	Optionals	Sonderzubehör	Options	Opcionales
---------	-----------	---------------	---------	------------



WJH1,5T-HC - WJH2T-HC

Il sistema boogie è ideale per le officine con pavimento non pari ed all'esterno - Rulli e ruote in poliuretano

The bogie system is ideal for workshops with uneven floors and outdoors - Polyurethane rollers and wheels

Ideal für Karosserie- und Lackierwerkstätten - Rollen und Räder aus Polyurethan

Les roues boogie sont idéales pour les ateliers aux sols inégaux et à l'extérieur des bâtiments - Rouleaux et roues en polyuréthane

El sistema de ruedas boogie es ideal para los talleres con piso irregular y al aire libre - Rodillos y ruedas de poliuretano



Ruote in gomma ad aria.

Air rubber tyres

Luftgummiräder. 5T-HC / 8T-HC / 10T-HC

Pneumatiques en caoutchouc

Ruedas neumáticas en goma



WJH1,5T-HC - WJH2T-HC





Tappo in gomma

Rubber pad

Gummiauflage

Tampon en caoutchouc

Tapón de goma





-  Cric idropneumatici per camion
-  **Hydropneumatic heavy duty jacks**
-  Hydropneumatische LKW-Heber
-  Crics hydropneumatiques pour poids lourds
-  Gatos hidro-neumáticos para camión



W122



W132B

-  Costruzione robusta per lavoro intensivo • Ruote con cuscinetto a sfera • Valvola limitatrice di carico
-  **Heavy duty design • Wheels with ball bearings • Overload safety valve**
-  Sehr robuste Konstruktion für intensive Arbeiten • Kugelgelagerte Räder • Überlastventil
-  Construction très robuste pour travail intensif • Roulettes avec roulement à billes • Soupape de surcharge
-  Construcción robusta para trabajo pesado • Ruedas con cojinete de bolas • Válvula limitadora de carga

W132/B - W122

40 - 60 t



Dati tecnici	Technical data	Technische Eigenschaften	Caractéristiques techniques	Datos técnicos	W132/B	W122
Portata	Capacity	Tragfähigkeit	Capacité	Capacidad de carga	40/20 t	60/30 t
Peso	Weight	Gewicht	Poids	Peso	39 kg	68 kg
Pressione	Pressure	Luftdruck	Pression	Presión	8 - 10 bar	8 - 10 bar

W132B

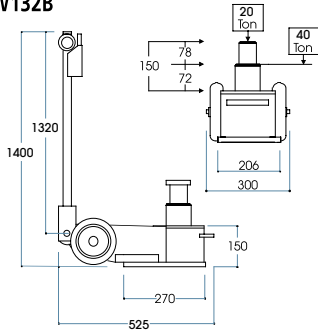

W122

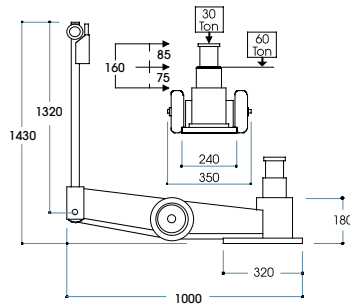

Kit Prolunghe (10,70,120 mm)

Extension kit (10,70,120 mm)

Verlängerungssatz (10,70,120 mm)





Kit de rallonges (10,70,120 mm)

Juego prolongaciones (10, 70, 120 mm)





W136 - W135 - W123

15-60 t



-  Cric idropneumatici per camion
-  **Hydropneumatic heavy duty jacks**
-  Hydropneumatische LKW-Heber
-  Crics hydropneumatiques pour poids lourds
-  Gatos hidro-neumáticos para camión



-  Costruzione robusta per lavoro intensivo • Ruote con cuscinetto a sfera • Valvola limitatrice di carico
-  **Heavy duty design • Wheels with ball bearings • Overload safety valve**
-  Sehr robuste Konstruktion für intensive Arbeiten • Kugelgelagerte Räder • Überlastventil
-  Construction très robuste pour travail intensif • Roulettes avec roulement à billes • Soupape de surcharge
-  Construcción robusta para trabajo pesado • Ruedas con cojinete de bolas • Válvula limitadora de carga

W136 - W135 - W123

15-60 t



Dati tecnici	Technical data	Technische Eigenschaften	Caractéristiques techniques	Datos técnicos	W136	W135	W123
Portata	Capacity	Tragfähigkeit	Capacité	Capacidad de carga	60/30 t	60/30/15 t	60/30/18 t
Peso	Weight	Gewicht	Poids	Peso	71 kg	50 kg	69 kg
Pressione	Pressure	Luftdruck	Pression	Presión	8 - 10 bar	8 - 10 bar	8 - 10 bar

W136

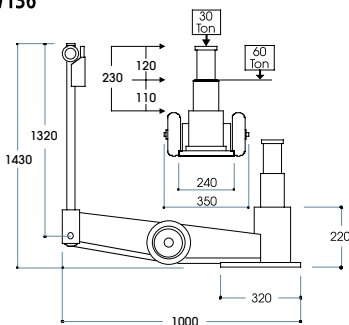

W135

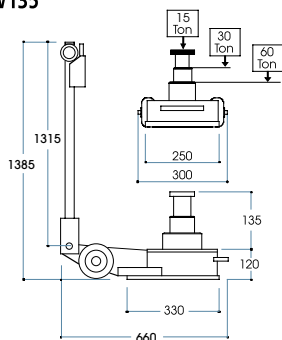

W123

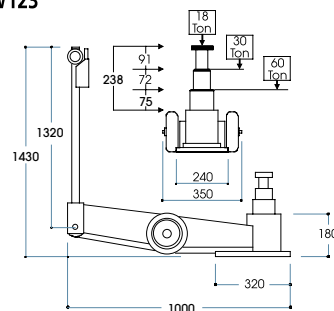

Kit Prolunghe (10,70,120 mm)

Extension kit (10,70,120 mm)





Verlängerungssatz (10,70,120 mm)

Kit de rallonges (10,70,120 mm)

Juego prolongaciones (10, 70, 120 mm)

W133 - W137 | 8-70 t







-  Cric idropneumatici per camion
-  **Hydropneumatic heavy duty jacks**
-  Hydropneumatische LKW-Heber
-  Crics hydropneumatiques pour poids lourds
-  Gatos hidro-neumáticos para camión



W133



W137

-  Costruzione robusta per lavoro intensivo • Ruote con cuscinetto a sfera • Valvola limitatrice di carico
-  **Heavy duty design • Wheels with ball bearings • Overload safety valve**
-  Sehr robuste Konstruktion für intensive Arbeiten • Kugelgelagerte Räder • Überlastventil
-  Construction très robuste pour travail intensif • Roulettes avec roulement à billes • Soupape de surcharge
-  Construcción robusta para trabajo pesado • Ruedas con cojinete de bolas • Válvula limitadora de carga

W133 - W137 | 8-70 t



Dati tecnici	Technical data	Technische Eigenschaften	Caractéristiques techniques	Datos técnicos	W133	W137
Portata	Capacity	Tragfähigkeit	Capacité	Capacidad de carga	70/43/23/13 t	44/32/22/14/8 t
Peso	Weight	Gewicht	Poids	Peso	77 kg	63 kg
Pressione	Pressure	Luftdruck	Pression	Presión	8 - 10 bar	8 - 10 bar

W133

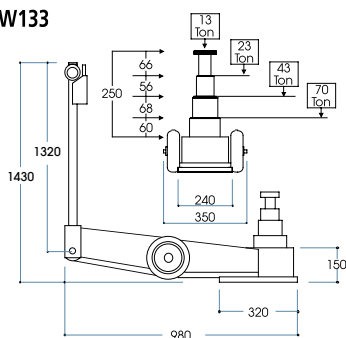



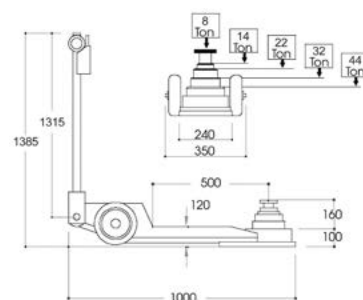

W137



- Kit Prolunghe (10,70,120 mm)
- Extension kit (10,70,120 mm)**
- Verlängerungssatz (10,70,120 mm)
- Kit de rallonges (10,70,120 mm)
- Juego prolongaciones (10, 70, 120 mm)

PL701 | 700 kg



-  Sollevatore idraulico per ruote singole o gemellari
-  Hydraulic wheel dolly for simple or twin wheels
-  Hydraulischer Zwillingsrad-Hubwagen für Einfach- oder Zwillingsräder
-  Chariot dépose roues pour roues simples où jumelées
-  Elevador hidráulico para ruedas individuales o gemelas





Dati tecnici	Technical data	Technische Eigenschaften	Caractéristiques techniques	Datos técnicos	
Portata	Capacity	Hubkraft	Capacité	Capacidad de carga	700 kg
Altezza minima	Min. lifting height	Min. Hubhöhe	Hauteur mini	Altura mínima	140 mm
Altezza massima	Max. lifting height	Max. Hubhöhe	Hauteur maxi	Altura máxima	660 mm
Interasse rulli	Distance between the wheel lifting rollers	Achsabstand Hubrollen	Distance entre les routeaux	Distancia entre ejes rodillos	min. 470 - max 740 mm
Comando a leva / pompa a semplice effetto	Single action pump / with lifting lever	Bedienungshebel / Einfachwirkende Pumpee	Levier de commande / Pompe simple effet	Mando por palanca / Bomba de acción simple	
Sicurezza idraulica in caso di sovraccarico	Overload safety valve	Überlastsicherung	Soupape de sécurité en cas de surcharge	Seguridad hidráulica en caso de sobrecarga	
Temperatura di lavoro	Working temperature	Arbeitstemperatur	Température de travail	Temperatura de trabajo	-10/+40°C
Dimensioni	Dimensions	Abmessungen	Dimensions	Medidas	1020x930x1130 mm
Peso	Weight	Gewicht	Poids	Peso	130 kg
Ruote pivotanti	Heavy duty castors for manoeuvrability	Lenkräder für Manövrierfähigkeit	Roues pivotantes	Ruedas pivotantes	

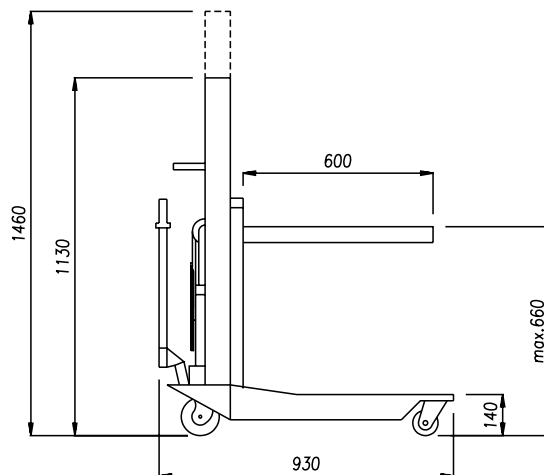
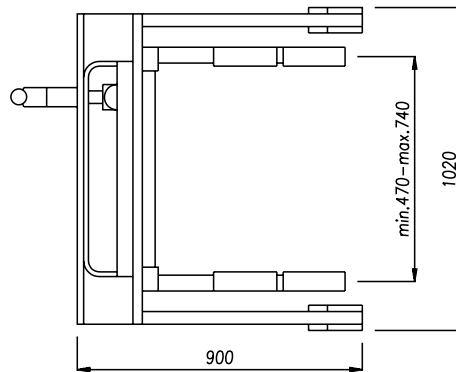

**W114 - W109 - W110 - W111
W112 - W113 - W210 - W160**

0,3-10 t



 Sollevatori idraulici da fossa

 Hydraulic gear box and transmission jacks

 Getriebeheber

 Crics de fosse

 Elevadores hidráulicos para fosa



W111



W113

 Pompa a pedale • Stelo cromato • Comando proporzionale di discesa tipo 'uomo morto' • Ruote piroettanti

 Pedal pump • Chromium plated piston rod • Proportional 'dead man' descent control • Castor wheels

 Pedalpumpe • Verchromte Kolbenstange • Proportionales 'Totmann'-Senkregelventil • Drehbar gelagerte Räder

 Pompe à pédale • Piston chromé • Baisse automatique proportionnelle type 'homme mort' • Roues pivotantes

 Bomba de pedal • Vástago cromado • Mando proporcional de descenso tipo 'hombre muerto' • Ruedas pivotantes

W114 - W109 - W110 - W111 W112 - W113 - W210 - W160

0,3-10 t



Dati tecnici	Technical data	Technische Eigenschaften	Caractéristiques techniques	Datos técnicos				
MOD.	W114	W109	W210	W110	W111	W112	W113	W160
A	1120	1140	850	1140	1140	880	970	1250
B	1970	1990	1870	1990	1940	1900	1950	2100
C	700	900	900	950	1000	1000	880	900
D	150	175	195	195	205	205	185	135
L	450	550	580	550	600	600	550	630
M	450	600	580	650	700	700	550	630
N	25	30	30	35	45	35	45	60
Kg	27	29	49	37	62	58	95	135

	W114	W109	W210	W110	W111	W112	W113	W160	
Portata Capacity Tragfähigkeit Capacité Capacidad de carga (kg)		300	500	800	1000	1500	1500	4000	10000
Pompa a doppia velocità Double speed pump Zweistufige Pumpe Pompe à double vitesse Bomba de doble velocidad				X	X	X	X	X	
Pistone a 2 sfili 2 stage piston 2-stufiger Kolben piston à 2 étages Pistón con 2 extracciones			X			X	X		
Supporto sfilabile Extractable transmission adapter Abnehmbarer Montagekorb Corbeille débâtable Soporte extraíble	X	X	X	X	X	X	X	X	

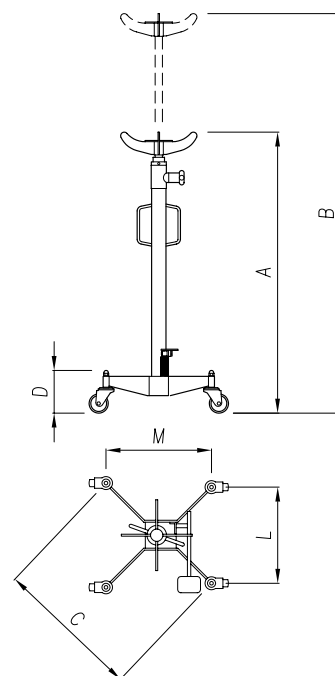

Opzioni	Optionals	Sonderzubehör	Options	Opcionales
---------	-----------	---------------	---------	------------

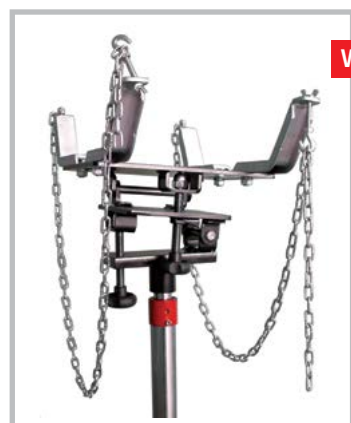

W115/5

W114 - W109 - W110 - W210 - W112

Supporto orientabile con boccole di riduzione, capacità 500 kg

Orientable transmission support with reduction bushes, 500 kg capacity

Schwenkbare Getriebehalterung mit Reduktionsbuchsen, Tragkraft 500 kg





Support orientable bour boîtes de vitesse avec douilles de réduction, capacité 500 kg

Soporte orientable, con casquillos reductores, capacidad 500 kg

903 - 906 - 911 - 912 LT917 - LT932

1-10 t



-  Colonnette
-  Axle stands
-  Unterstellböcke
-  Chandelles
-  Columnas







911



903



LT932

											
Dati tecnici		Technical data		Technische Eigenschaften		Caractéristiques techniques		Datos técnicos			
						903	906	911	912	LT917	LT932
Portata	Capacity	Capacité	Tragfähigkeit	Capacidad de carga	1000 kg	1000 kg	3000 kg	5000 kg	7500 kg	10000 kg	
Altezza min	Min. height	Hauteur min.	Minimalhöhe	Altura mín.	1030 mm	280 mm	320 mm	380 mm	1385 mm	1400 mm	
Altezza max	Max. height	Hauteur max.	Maximalhöhe	Altura máx.	1720 mm	490 mm	530 mm	580 mm	2065 mm	2060 mm	





WERTHER INTERNATIONAL SpA

via Brunelleschi 12, - 42124 Reggio Emilia ITALY

Tel. +39 0522 9431 / +39 346 98 37 325 / +39 346 98 37 443 / Fax +39 0522 941997

info@wertherint.com

www.wertherint.com